

As the only complete line of probes available, Beau Tech MilProbes are available in three sizes to satisfy any pitch size to 2 mil!

Available MilProbe Sizes:

- 1 MilProbes
- 10 MilProbes
- 25 MilProbes

Features:

- 1 MilProbes are made of a special, high tech alloy to provide the necessary strength.
- 10 and 25 MilProbes are manufactured with a special age-hardened stainless steel with a hardness above RC52 and tensile strength greater than 310,000 PSI.

Benefits:

These features give our Beau Tech tools the longevity you need to save time and money.

- **They do not have to be replaced as often.**
"Beau Tech tools last 3 times as long..."
- **Production is not slowed by worn tools.**
- **Errors caused by damaged tools are avoided.**

All Beau Tech Tools and Soldering Aids are manufactured with quality materials and workmanship. They are designed to satisfy ESD and user needs.

Please fax the following info to 207-775-7710.

Or use our website form: www.beautech.com

- Please send me a full line catalog of all Quality Beau Tech Tools and Soldering Aids.
- Please contact me, I have a need for a special tool.
- Please send me a sample of MilProbe (no kits) Model# _____

You must complete the following information to qualify for the sample. Please print. Thank you.

Name _____

Job Title _____

Function _____

Company _____

Address _____

e-mail _____

Tel. _____

Fax _____

Web Address _____

Type of Activity at Your Plant/Location:

- Packaging Assembly Rework/Repair
- Other: _____

Number of Production Assemblers:

1-50___ 51-100___ 101-500___ 501+___

Mil Pitch Size of Components Used (list all):

2-15___ 15-25___ 25-30___ 30+___ TH ___

Your Tool Distributor: (Please include phone no.)

BEAU TECH, INC.
98 ELM ST.
PORTLAND, ME 04101 USA

BEAU TECH™

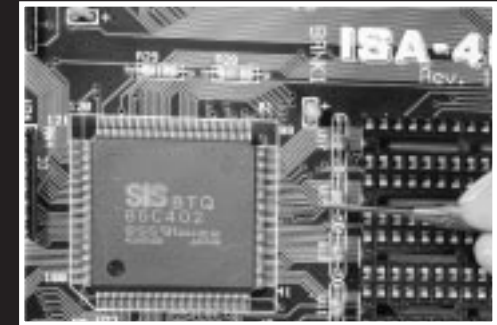

Tools for the Latest Developments in Component and Assembly Technologies

- Through Hole
- Surface Mount
- Fine Pitch
- Tape Automated Bonding
- Ball Grid Array

RoctHard MilProbes

For more information on products and distributors, please contact us at:
BEAU TECH, Inc. • 98 Elm Street • Portland, Maine 04101, U.S.A.
Tel: 1-207-775-6139 • Fax 1-207-775-7710
email: info@beautech.com • Internet: <http://www.beautech.com>



Ultra Fine Pitch 1 MilProbes

These unique tools are made of a special, high-tech alloy to provide the strength needed to repair and rework ultra-fine pitch leads and pads from 2 to 10 mil. Suitable for working BGA, Flip Chip, TAB, COB, Chip & Wire, Wire Bonding, etc.

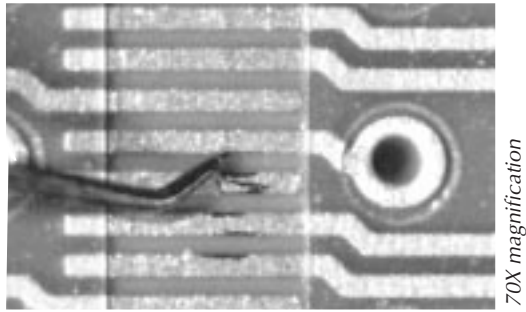

70X magnification

1 MilProbe cleaning 3 mil pitch TAB substrate.

Fine Pitch 10 MilProbes

These are the only tools available that can reach between fine pitch leads from 10 to 25 mil with adequate strength for lead repair and rework. Suitable for working QFP and other SMT components and boards.

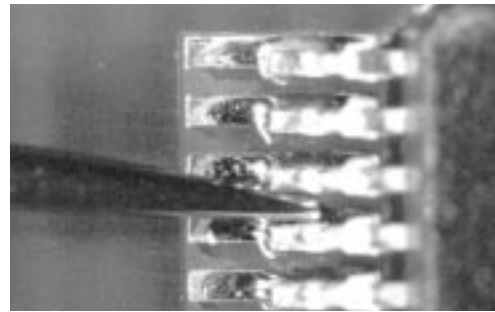

15X magnification

10 MilProbe straightening leads of 20 mil pitch QFP.

SMT/TH 25 MilProbes

These are the most versatile tools for TH and SMT for pitch sizes above 25 mil. These MilProbes have a useful life that has been proven to be more than three times that of other domestic or imported brands.



15X magnification

25 MilProbe used to test solder joint of 30 mil pitch QFP.

These Made in America, Beau Tech RocHard MilProbes are the only complete line of probes available to meet the full spectrum of circuit repair, rework and assembly needs from Through Hole to 2 mil pitch Surface Mount. They are designed to save the replacement costs of inferior tools and to avoid the inefficiency and damage caused by worn tools.

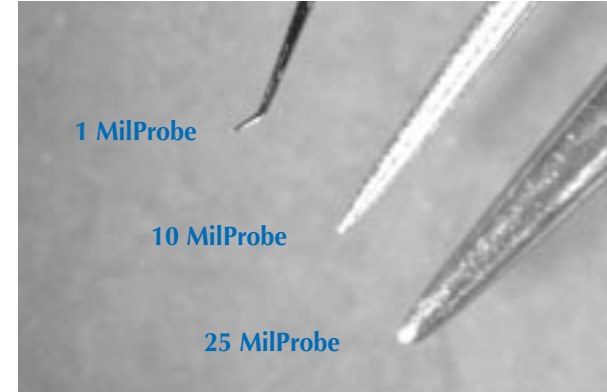

Relative size comparison at 20X magnification

MilProbe Selection Guide

A = 1 MilProbes B = 10 MilProbes C = 25 MilProbes

Pitch Size	2-10 mil	10-15 mil	15-25 mil	25-30 mil	30+ mil	Through-Hole
Application						
Testing Solder Joint & Wire Bonding Strength	A	A&B	B	B&C	C	C
Straightening Leads & Wires	A	A&B	B	B&C	C	C
Cleaning Leads & Traces	A	A	B	B	C	C
Applying Epoxy	A	A	B	B	C	C

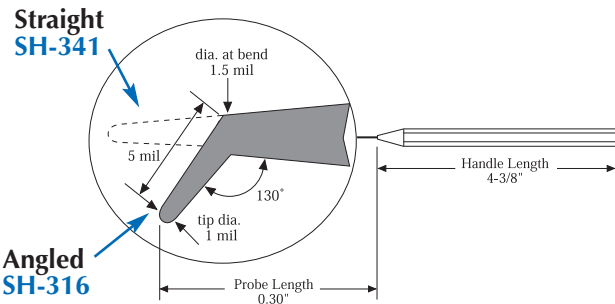

Overall dimensions of the 1 MilProbe Straight and angled version. Patent Pending

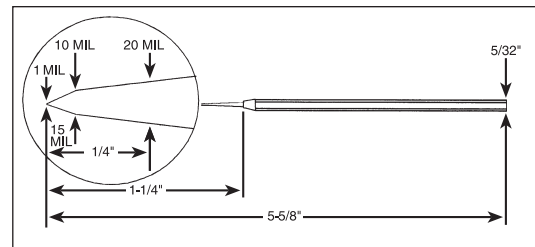

Overall dimensions of all 10 MilProbes Patent Pending

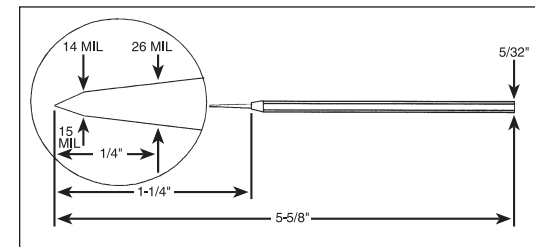

Overall dimensions of all 25 MilProbes

1 MilProbes MODEL NUMBERS

- SH-316 – Angled 1 MilProbe
- SH-341 – Straight 1 MilProbe
- SH-322 – Kit containing one each of 1 MilProbes

(Understandably, the 1 MilProbe is so fine that a photo is unable to show the probes' detail as with 10 and 25 MilProbes.)

10 MilProbes MODEL NUMBERS

- SH-216 – Angled 10 MilProbe
- SH-241 – Straight 10 MilProbe
- SH-222 – Kit containing one each of 10 MilProbes

25 MilProbes MODEL NUMBERS

- SH-116 – Angled
- SH-141 – Straight
- SH-117 – Double Angled
- SH-123 – Curved
- SH-125 – Kit containing one each of 25 MilProbes